

Lever and Push Operation Type

TS-1501 & TS-1501B Series

Compact, thin-profile horizontal type suitable for a wide range of applications.

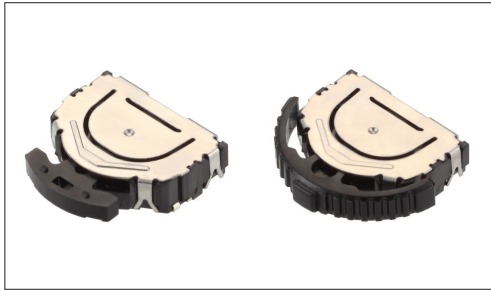

- Directional resolution: 2-direction
- Ratings (max.)/(min.) (Resistive load): 10mA 5V DC/50μA 3V DC
- Operating temperature range: -40°C to +85°C

Applications: Audio_TV:Cameras

■ Product List

Products No.	Actuator configuration	Push-on switch	Operating force		Travel (Center push) (mm)	Location lug	Dimensions (W×D×H) (mm)	Automotive	Drawing No.
			Lever portion	Push portion					
TS-1501-200	Mounting knob	With	0.65±0.3N	2±1N	Refer to the dimensions	With	11.8×11.4×3.0	—	1
TS-1501B-200	Mounting knob integrated	With	0.65±0.3N	2±1N	Refer to the dimensions	With	11.8×11.4×3.0	—	2

⚠ Note

1. This catalog shows only outline specifications. When using the products, please obtain formal specifications for supply.
2. Please place purchase orders for taping products per minimum order unit (1 reel or a case).

■ Packing Specifications

Taping

Number of packages (pcs.)			Tape width (mm)	Export package measurements (mm)
1 reel	1 case / Japan	1 case / export packing		
1,350	2,700	5,400	24	428×413×172

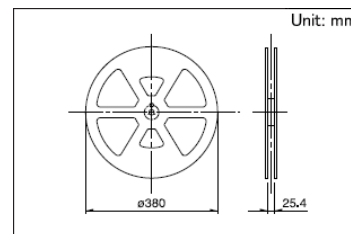

Drawing No. 1

■ Dimensions

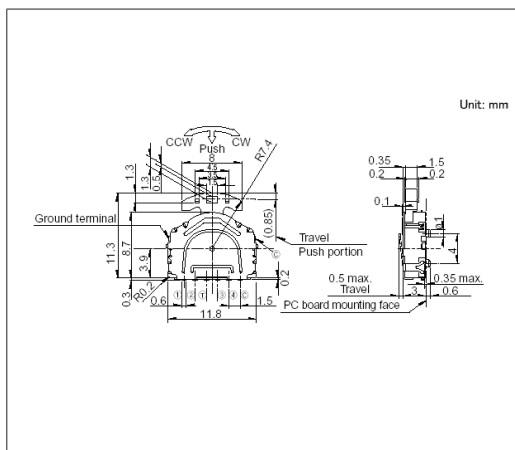

■ Land Dimensions

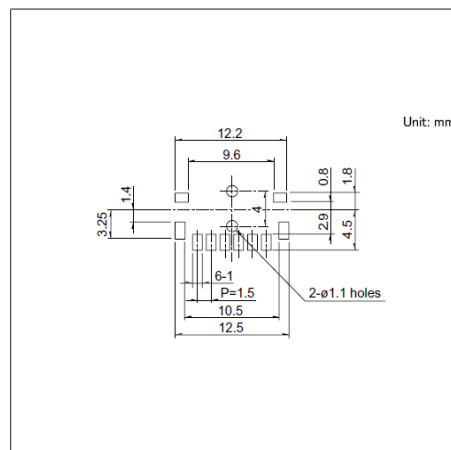

Viewed from mounting face.

■ Circuit Diagram

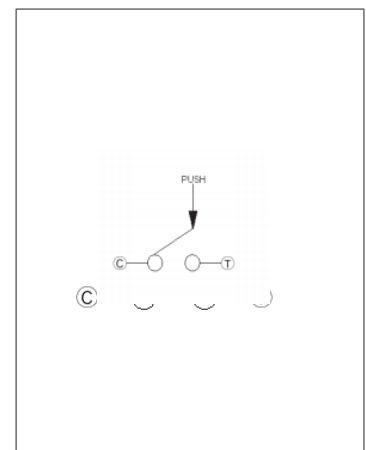

Push portion.

TS-1501 & TS-1501B Series

Drawing No.2

■ Dimensions

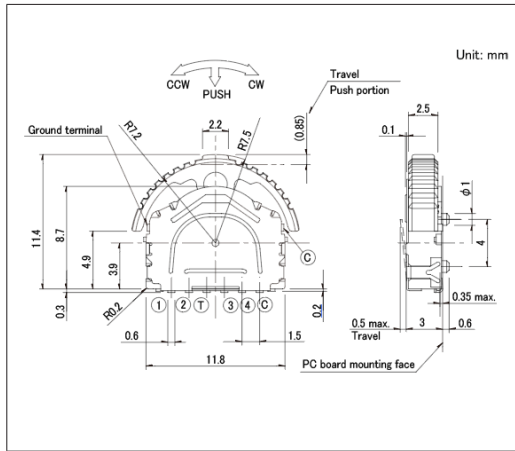

■ Land Dimensions

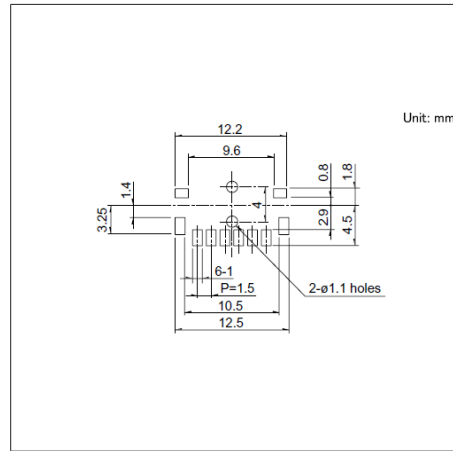

Viewed from mounting face.

■ Circuit Diagram

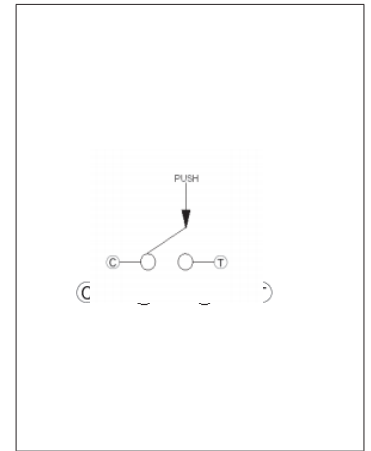

Push portion.